

Revision Notes			
R1 -			
APPA: -	Drawn: -	Checked: -	Approved: -
			Date: -

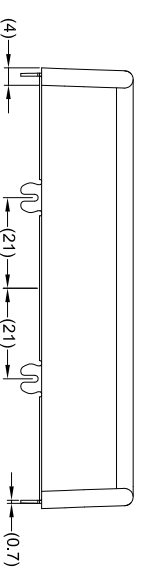
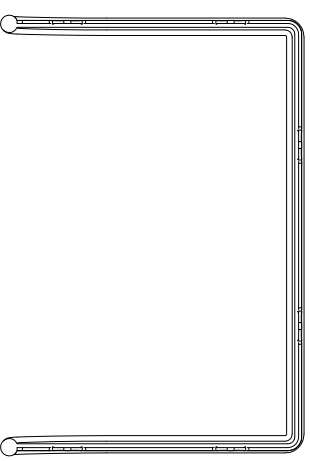
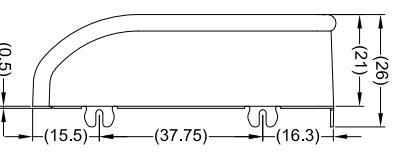
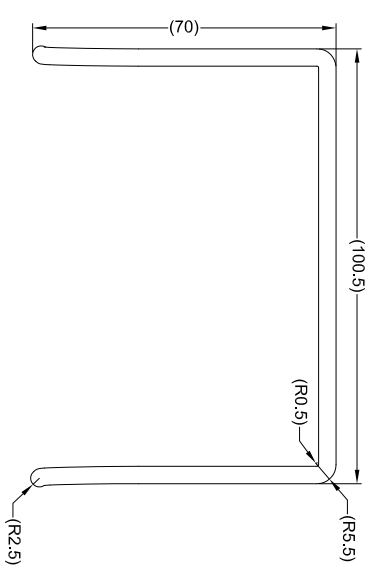
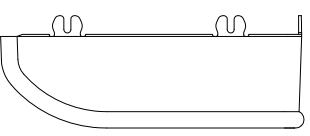
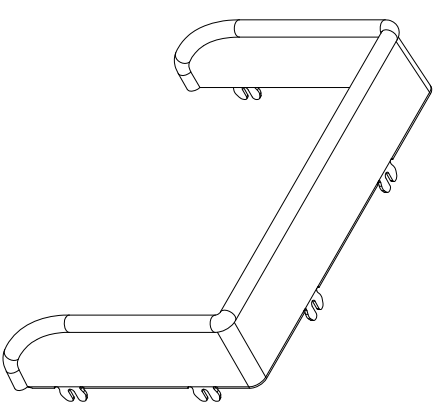
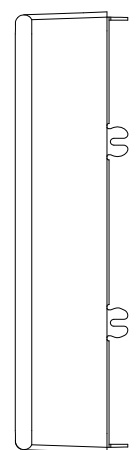

- NOTES:
1. FINISH: TEXTURED, MATT BLACK.
  2. MATERIAL: ABS-757.

PROPRIETARY NOTICE  
 THIS DESIGN AND TECHNICAL INFORMATION APPEARING ON THIS DRAWING IS THE PROPERTY OF BRIGADE ELECTRONICS, AND IS DISCLOSED IN CONFIDENCE. IT IS NOT TO BE COPIED, REPRODUCED, REVEALED TO OR EXPLOITED BY OTHERS, EITHER IN WHOLE OR IN PART WITHOUT THE EXPRESS WRITTEN CONSENT OF BRIGADE ELECTRONICS.

**BRIGADE**  
 www.brigade-electronics.com

 Third Angle	Assembly Pl Approval	Approved by	Checked by	Drawn by
	WENFENG QIN (03/04/14)	B. JOHN	RBATES	M BUTLER
Angle of Projection	Units	Scale	Released	Assembly Ref
	mm	N/A	03/04/14	VBV-750M-SS
Status	Part No	BE-002716-00-13		
RELEASED	4366			

1 2 3 4 5 6 7 8  
 H G F E D C B A  
 H G F E D C B A  
 Frame V3